

# Ancon<sup>®</sup>

## Lockable Dowels and Locking Pins

for Temporary Movement Joints



# **We are one team.** **We are Leviat.**

Leviat is the new name of CRH's construction accessories companies worldwide.

Under the Leviat brand, we are uniting the expertise, skills and resources of Ancon and its sister companies to create a world leader in fixing, connecting and anchoring technology.

The products you know and trust will remain an integral part of Leviat's comprehensive brand and product portfolio. As Leviat, we can offer you an extended range of specialist products and services, greater technical expertise, a larger and more agile supply chain and better, faster innovation.

By bringing together CRH's construction accessories family as one global organisation, we are better equipped to meet the needs of our customers, and the demands of construction projects, of any scale, anywhere in the world.

This is an exciting change. Join us on our journey.

Read more about Leviat at [Leviat.com](https://www.leviat.com)



Our product brands include:

**Ancon**<sup>®</sup>

**Connolly**

**H**  
**HALFEN**

**HELIFIX**

**ISEDIO**

**PLAKA**



**60**

locations

sales in  
**30+**  
countries

**3000**

people worldwide

Imagine. Model. Make.

[Leviat.com](https://Leviat.com)

# Lockable Dowels and Locking Pins

## Contents

<a href="#">The 'Lockable' Range</a>	4
<a href="#">Advantages &amp; Applications</a>	4-5
<a href="#">Range of Lockable Dowels &amp; Locking Pins</a>	6-8
<a href="#">Typical Combined Applications</a>	9
<a href="#">Performance Data, Spacings, Reinforcement Details &amp; Dimensions</a>	10-14
<a href="#">Installation Procedures</a>	15-16
<a href="#">Projects</a>	17
<a href="#">Other Ancon Products</a>	17

Australia Patent No. 2008294503  
 New Zealand Patent No. 583887  
 US Patent No. 8209933  
 Singapore Patent No. 159760  
 South Africa Patent No. 2010/01651  
 Other patents pending

Ancon Lockable Dowel

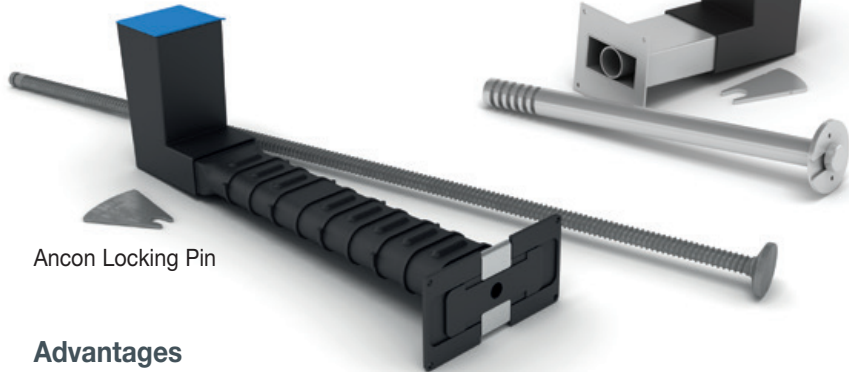

Ancon Locking Pin

## The 'Lockable' Range

Lockable Dowels and Locking Pins are unique, patented products. They were developed by Leviat for use at temporary movement joints, most commonly found in post-tensioned concrete frames. They allow initial shrinkage of the concrete to take place and are then locked in position, by mechanical and chemical means, to prevent further movement taking place.

They also provide many advantages over the site-assembled arrangement of carbon steel reinforcing bar, galvanised or plastic ducting, vent tubes and a non-specific grout, which is sometimes used by contractors.

Lockable Dowels transfer shear load in both their locked and unlocked state which reduces slab propping times and accelerates the rate of construction.

Locking Pins are ideal for applications where there is little or no shear load.

When used together, or in combination with other Ancon shear load connectors these unique 'lockable' products provide a cost-effective and practical fixing solution. Contact us with your project details.

## Advantages

The use of Lockable Dowels can save a significant amount of time and materials over other construction methods. Concrete shrinkage has traditionally been accommodated by leaving gaps in the slab called 'pour strips' or 'closure strips'. These strips are filled once movement has stabilised, however until they are filled the slabs must be propped, restricting site access and delaying site progress. Gaps in the slab also create a trip hazard for site workers, use additional formwork and can leave the soffit face marked.

Lockable Dowels improve site access, minimise formwork requirements and accelerate the rate of construction. With a Lockable Dowel, there is less requirement for the slabs to be propped or a support corbel to be constructed, as shear load is transferred by the dowel. The time saved by early removal of slab props can be significant.

In addition, engineers have found the Ancon Lockable Dowel to be the preferred design solution for pin-ended joints. Although it is customary for practical reasons to use U-bars or other rebar continuity systems at these connections, these options do not truly act as hinges and so rotation of the slab under load

can induce cracking at the wall-to-slab interface with potential integrity issues.

The Lockable Dowel is closer to a true pin-ended joint and, being manufactured from stainless steel, provides additional corrosion protection over systems using carbon steel reinforcement.

The design capacities shown on page 10 are backed by independent test data and the unique void former allows inspection of the dowel before the joint is locked.

Standard Ancon systems are available for use at slab joints and retaining / core walls.

- ✓ Eliminate pour strips
- ✓ Reduce propping times
- ✓ Reduce formwork
- ✓ Improve site access
- ✓ Faster, safer construction
- ✓ Proven performance
- ✓ Simple installation
- ✓ Guaranteed alignment allows movement
- ✓ Allow inspection before locking



The performance of site assembled systems can be unreliable



Pour Strips restrict site access, cause a trip hazard and delay progress on site



The Lockable Dowel eliminates the need for Pour Strips, accelerating the speed of construction and improving site safety

## Applications

In most cases, Ancon Lockable Dowels can be used to replace pour strips at temporary movement joints in post-tensioned concrete frames. Standard Ancon systems are available for use at slab joints and retaining / core walls.

“The consulting design engineer wanted a one metre wide pour strip to be left open for 90 days which wasn’t acceptable to Hansen Yuncken. Using the Ancon Lockable Dowel system allowed earlier formwork stripping and work to continue with our services, thereby reducing overall construction time.”

Brent Courtney, Senior Site Manager, Hansen Yuncken QLD

“The Lockable Dowel is a very clean system. If you have encountered pour strips before, the Lockable Dowel is a no-brainer.”

Mahmoud Farawi, Skanska USA



### Slab-to-Slab

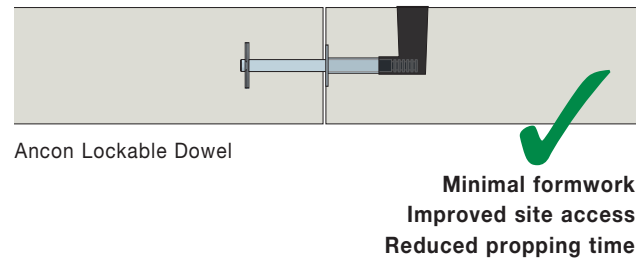
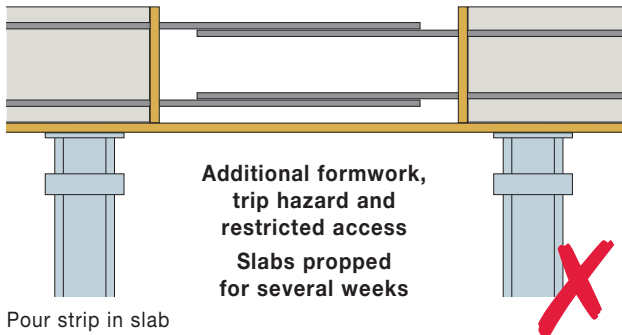

### Slab-to-Wall

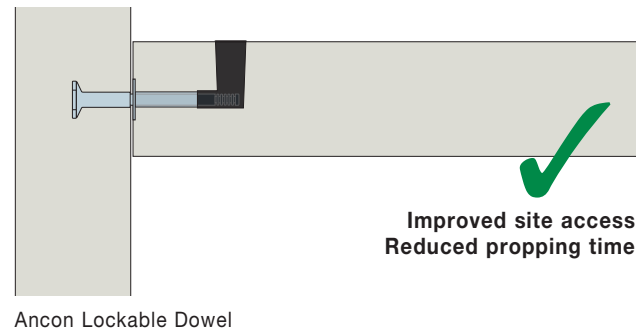
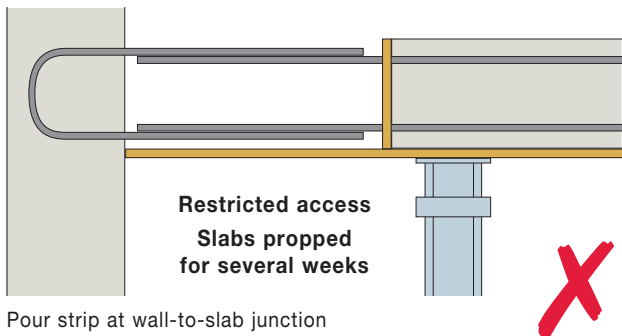

### Slab-to-Slab

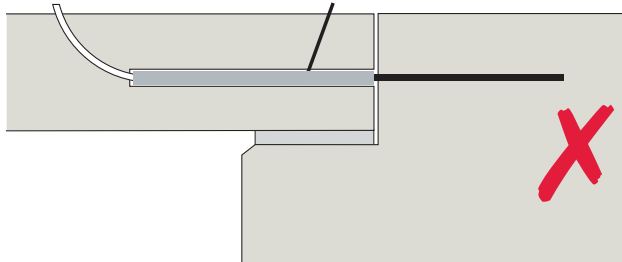

Unreliable performance  
Blind installation

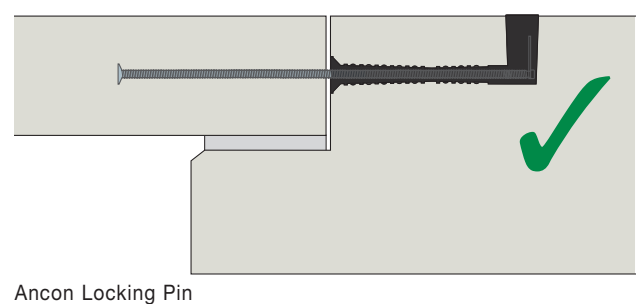

# Lockable Dowels and Locking Pins

## Range of Lockable Dowels

A Lockable Dowel allows initial shrinkage of the concrete to take place and then, after a pre-determined time period (generally 3-4 weeks), is locked in position with a mechanical plate and a controlled amount of epoxy resin. The range comprises three products; ESDQ-L20, HLDQ-L30 and ESDQ-L20W.

## Slab-to-Slab Lockable Dowels

### ESDQ-L20

The dowel component is manufactured from 30mm diameter stainless steel; one end features two fixed overlapping anchor discs and the other has a series of grooves to accept the Locking Plate. The cylindrical sleeve which accepts the dowel component is contained within a box-section to allow lateral, longitudinal and some rotational movement. The epoxy resin is poured into the L-shaped void former. This product has a design capacity of up to 71kN. See pages 10-13 for full technical details.

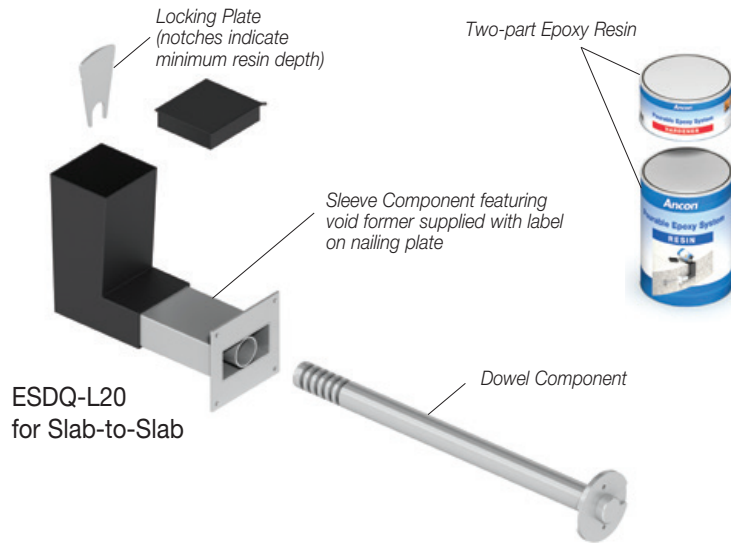

Reinforcement being located around ESDQ-L20 Sleeves

### HLDQ-L30

The HLDQ-L30 is a high load Lockable Dowel with a design capacity of up to 136kN. See pages 10-13 for full technical details.



HLDQ-L30 Sleeve nailed to formwork

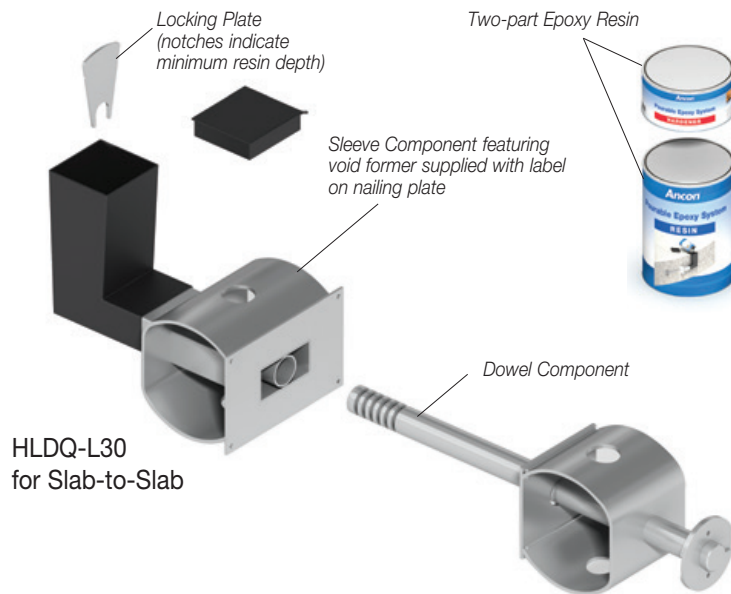

### Example Specification Clause

Delete/Amend blue text as appropriate

<Ancon ESDQ-L20 or Ancon HLDQ-L30> lockable shear load connector comprising dowel, sleeve and locking components to be installed at the temporary movement joint between two slabs. Product to be positioned at <insert centres>mm horizontal centres at <the centre line of the slab or XXXmm from the top of the slab>. The dowel is to be locked in position after <insert time period> using the locking plate and resin supplied. System should be installed in accordance with Ancon lockable dowel instructions and engineer's drawings.

## Slab-to-Wall Lockable Dowel ESDQ-L20W

The dowel component is manufactured from 30mm diameter stainless steel, but is shorter than the ESDQ-L20 dowel. One end of the dowel is designed to fix into the stainless steel Ancon SKS24 Threaded Anchor cast into the face of the concrete and the other end features a series of grooves to accept the Locking Plate. The sleeve component is the same as used in the ESDQ-L20. See pages 10-13 for full technical details.



Sleeve pushed over dowel component at core wall

### Example Specification Clause

Delete/Amend blue text as appropriate

Ancon ESDQ-L20W lockable shear load connector comprising dowel, sleeve, threaded anchor and locking components to be installed at the temporary movement joint between slab and wall. Product to be positioned at <insert centres>mm horizontal centres at <the centre line of the slab or XXXmm from the top of the slab>.

The dowel is to be locked in position after <insert time period> using the locking plate and resin supplied. System should be installed in accordance with Ancon lockable dowel instructions and engineer's drawings.

### Epoxy Resin

Each dowel is locked after a pre-determined time period (generally 3-4 weeks) with a high quality, two-part epoxy resin. The resin is mixed and poured into the L-shaped void former. Each dowel requires 1,500g of resin. Users are required to take note of storage conditions and mixing instructions given on the packaging.

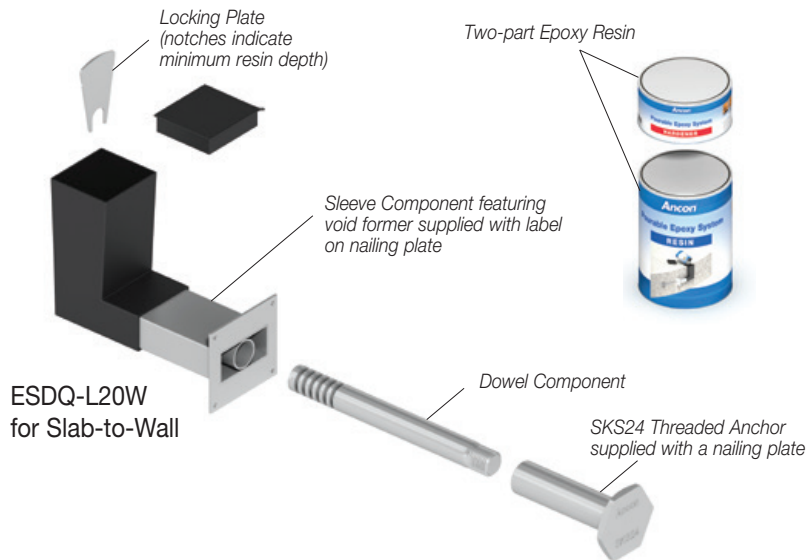

Void formers shown at Slab-to-Wall joint

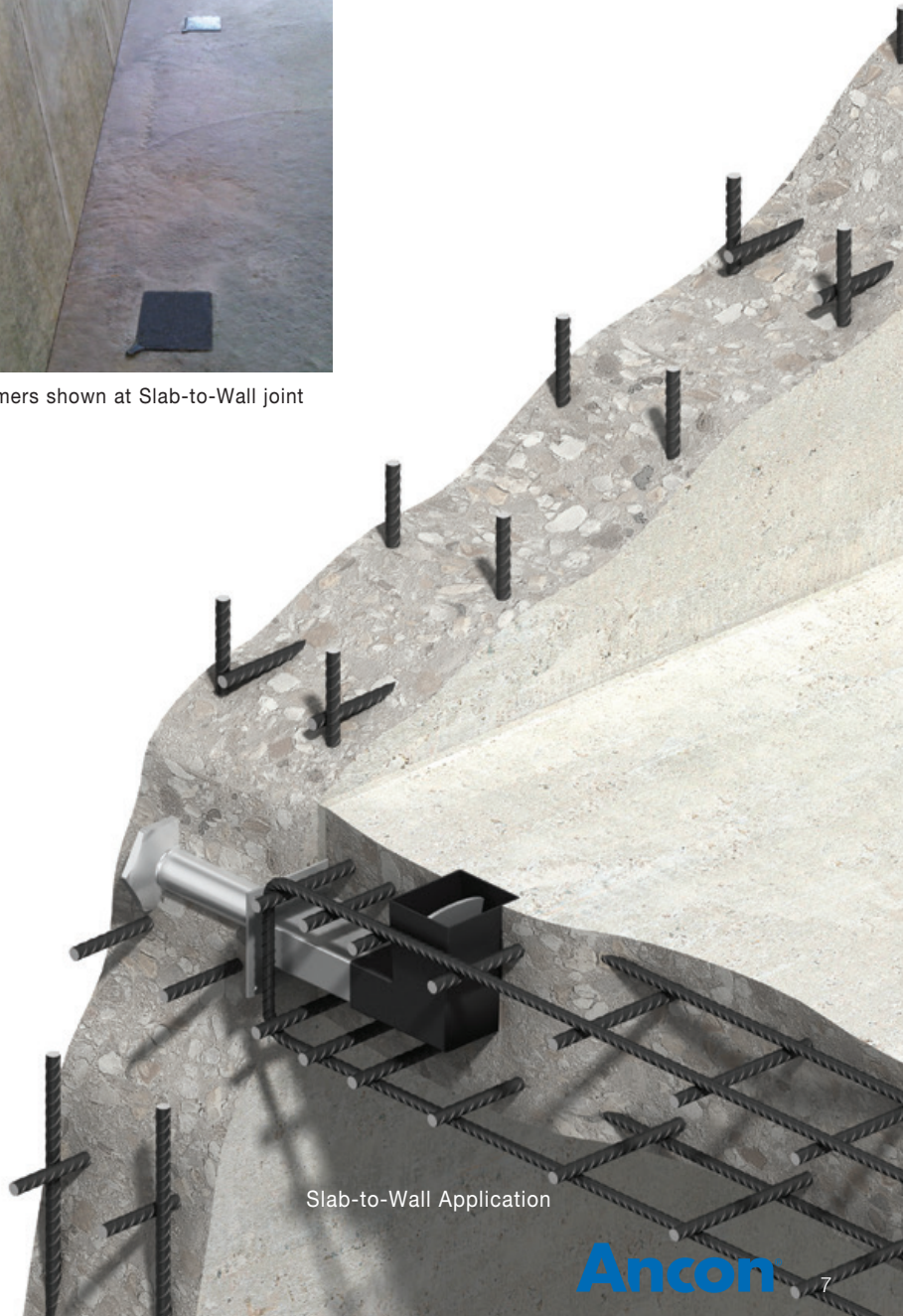

Slab-to-Wall Application

# Lockable Dowels and Locking Pins

## Range of Locking Pins

A Locking Pin allows initial shrinkage of the concrete to take place and then, after a pre-determined time period (generally 3-4 weeks), is locked in position with a mechanical plate and a controlled amount of Ancon high strength, cementitious, non-shrink grout. The range comprises the ALP19 for slab-to-slab applications and the ALP19W for slab-to-wall applications.

## Slab-to-Slab Locking Pin

### ALP19

The pin component is manufactured from 500MPa coil bar which comprises a constant rolled thread. One end of the pin features a hot forged head which increases its resistance to tensile forces; the size of this head complies with the AUS/NZ standard for headed reinforcement. The other end of the pin features a notch to accept the Ancon locking plate.

When installed in the heavy duty injection moulded sleeve, the pin component is suspended in a tube; a locating bush and pinch points cradle the bar to ensure even distribution of the grout. The sleeve allows lateral and some rotational movement of the pin, in addition to longitudinal movement, prior to locking. The sleeve is ribbed on the outside for increased bond with the concrete and features indentations on the inside to maximise grout bond. The sleeve features the standard Ancon void former. A blue lid allows easy identification on site, differentiating it from a Lockable Dowel in a cast slab.

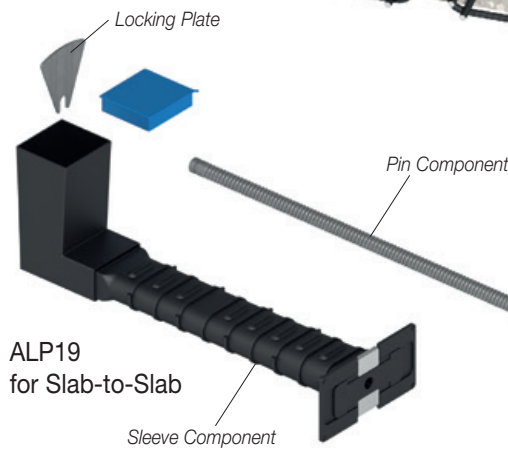
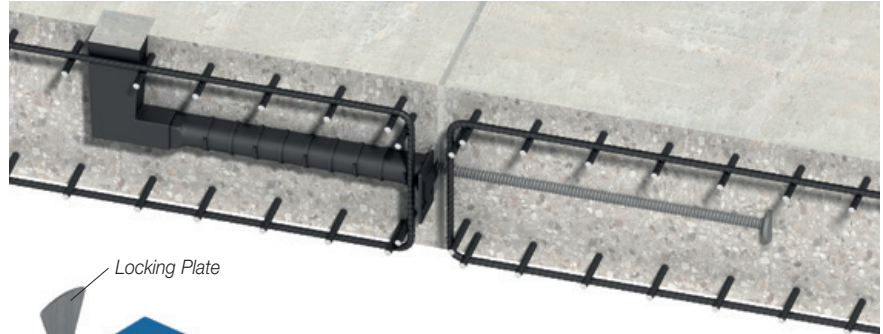

ALP19  
for Slab-to-Slab

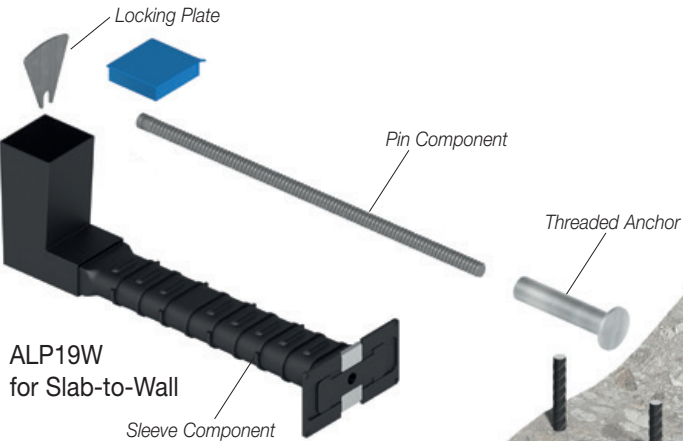

ALP19W  
for Slab-to-Wall

## Slab-to-Wall Locking Pin

### ALP19W

For walls, the pin component is manufactured from 500MPa coil bar like in the slab-to-slab system but is shorter in length. One end of the pin screws directly into a threaded anchor (product ref. ALP19TA) that is cast into the face of the concrete wall and the other end features a notch to accept the proprietary Locking Plate. The sleeve component is the same as used in the standard slab-to-slab ALP system.

### High Strength Grout

In combination with the mechanical locking plate, the Pin is locked with Ancon high strength, cementitious, non-shrink grout. We recommend the grout is mixed to a flowable consistency which, at a normal curing temperature (20°C), achieves a compressive strength of 20MPa in 24 hours and 75MPa in 28 days. Users should refer to storage and mixing instructions supplied with the product.



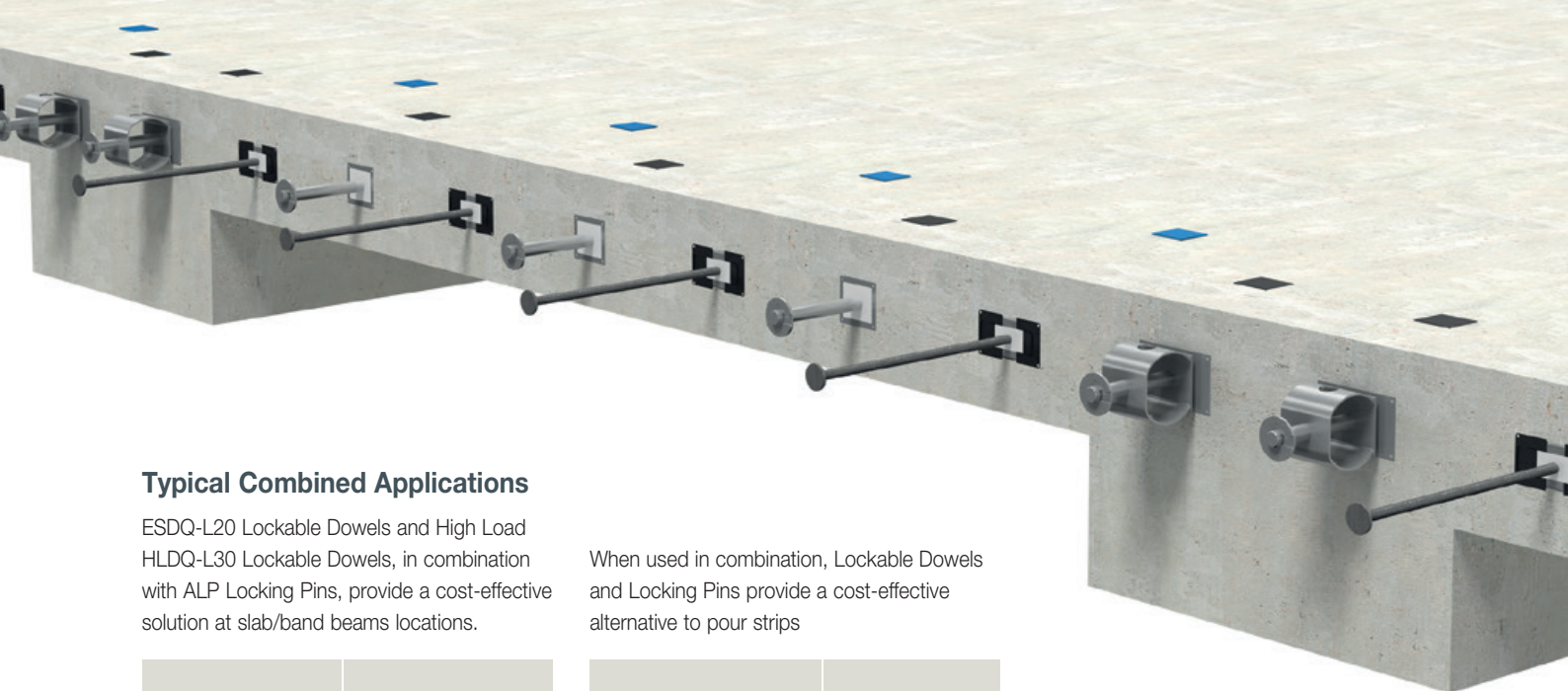

## Typical Combined Applications

ESDQ-L20 Lockable Dowels and High Load HLDQ-L30 Lockable Dowels, in combination with ALP Locking Pins, provide a cost-effective solution at slab/band beams locations.

When used in combination, Lockable Dowels and Locking Pins provide a cost-effective alternative to pour strips

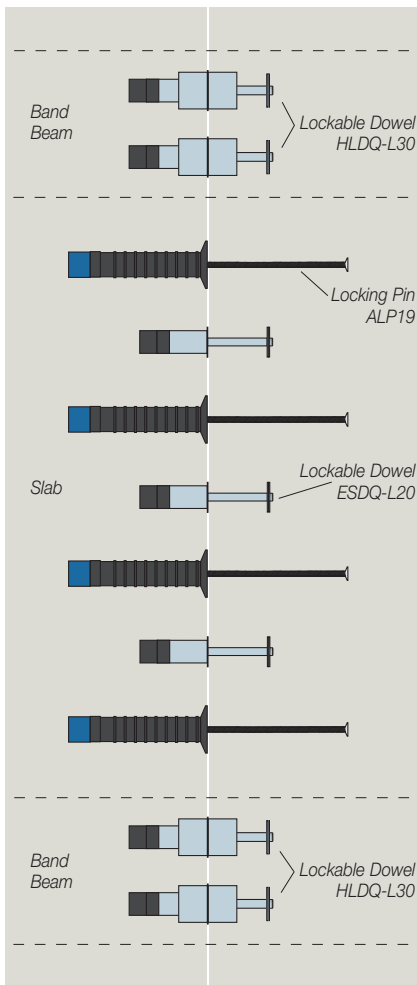

Slab and band beam typical configuration

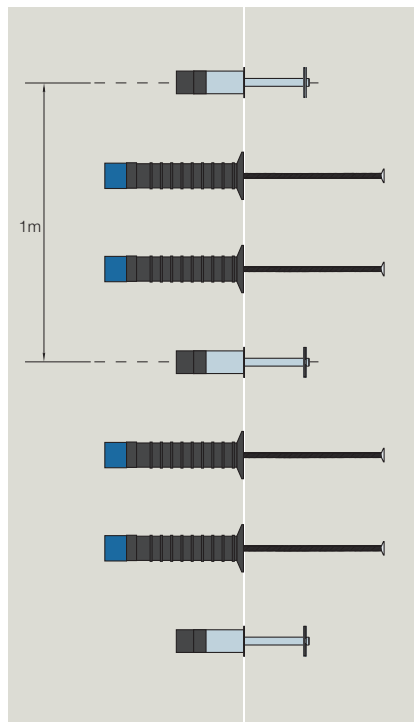

Typical temporary movement joint configuration

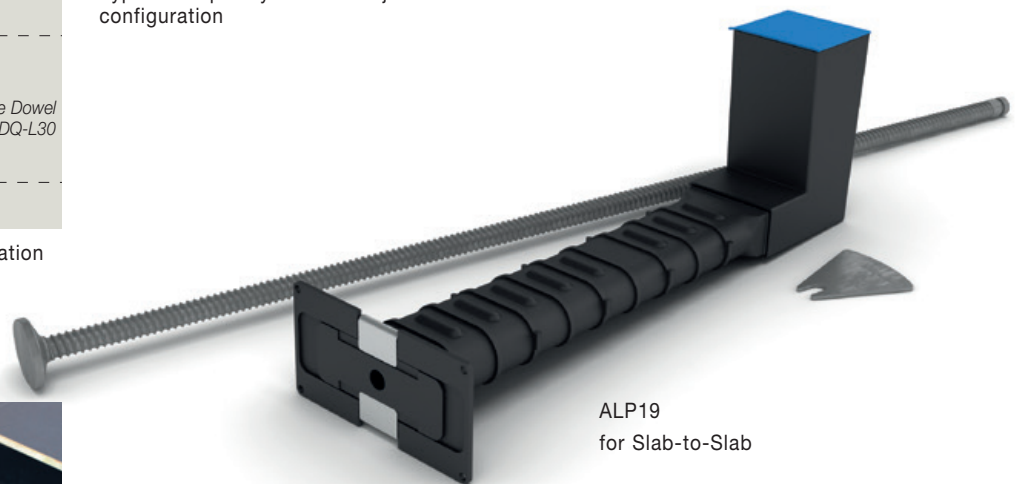
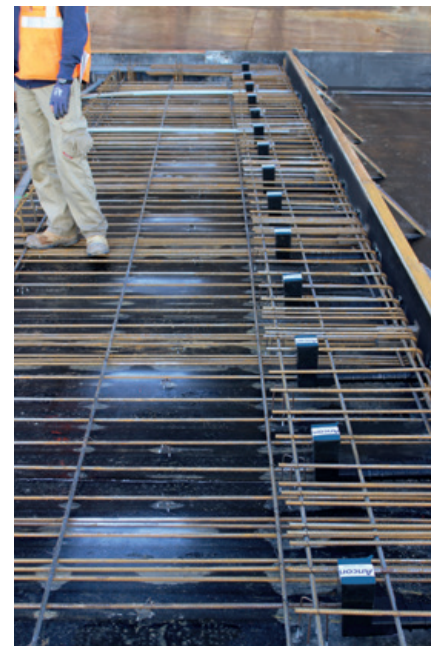

ALP19  
for Slab-to-Slab



# Lockable Dowels and Locking Pins

## Lockable Dowel Design Strengths

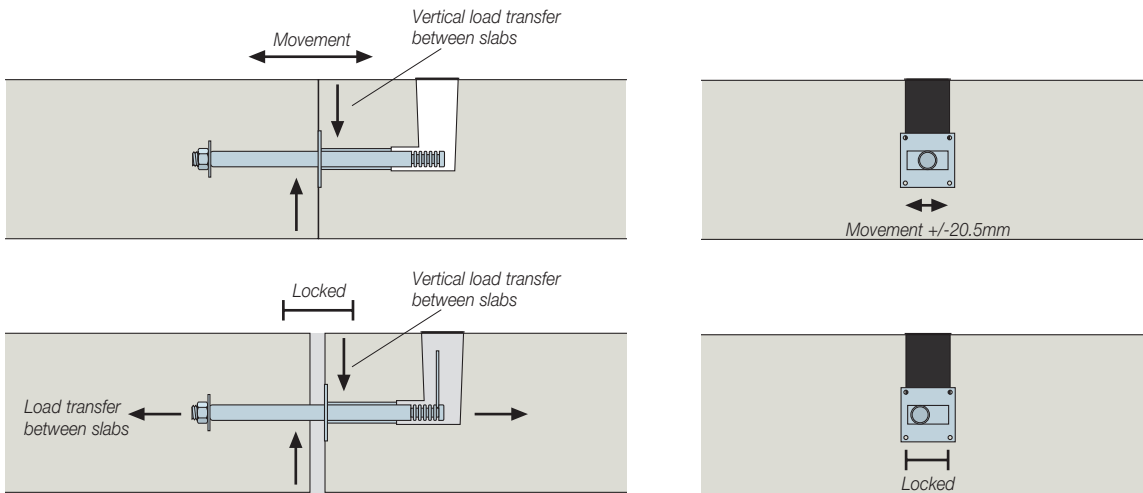

### ESDQ-L20 Lockable Dowels (slab-to-slab)

Slab Thickness (mm)	Tension along line of dowel (kN)	Vertical Design Resistance (kN) at Various Design Joint Widths (mm) in 32MPa Concrete							
		5	10	15	20	25	30	35	40
160	45	12.0	12.0	12.0	12.0	12.0	12.0	12.0	12.0
180	65	25.0	25.0	25.0	25.0	25.0	25.0	25.0	25.0
200	80	40.0	40.0	40.0	40.0	40.0	40.0	40.0	40.0
220	100	53.6	53.6	53.6	53.6	53.6	53.6	53.6	52.7
240	100	62.2	62.2	62.2	62.2	60.6	57.8	55.2	52.7
260 and above	100	71.4	69.9	66.6	63.5	60.6	57.8	55.2	52.7

### ESDQ-L20W Lockable Dowels (slab-to-wall)

Slab Thickness (mm)	Tension along line of dowel (kN)	Vertical Design Resistance (kN) at Various Design Joint Widths (mm) in 32MPa Concrete							
		5	10	15	20	25	30	35	40
160	45	12.0	12.0	12.0	12.0	12.0	12.0	12.0	12.0
180	65	25.0	25.0	25.0	25.0	25.0	25.0	25.0	25.0
200	80	40.0	40.0	40.0	40.0	40.0	40.0	40.0	40.0
220	80	53.6	53.6	53.6	53.6	53.6	53.6	53.6	52.7
240	80	62.2	62.2	62.2	62.2	60.6	57.8	55.2	52.7
260 and above	80	71.4	69.9	66.6	63.5	60.6	57.8	55.2	52.7

### HLDQ-L30 Lockable Dowels (slab-to-slab)

Slab Thickness (mm)	Tension along line of dowel (kN)	Vertical Design Resistance (kN) at Various Design Joint Widths (mm) in 32MPa Concrete							
		5	10	15	20	25	30	35	40
240 and above	100	136.0	136.0	136.0	136.0	136.0	136.0	136.0	121.9

#### ESDQ-L20 Example

Slab thickness	= 240mm
Joint width	= 20mm
Concrete strength	= 32MPa
Characteristic permanent action (dead load)	= 45kN/m $\lambda_G = 1.2$
Characteristic variable action (imposed load)	= 50kN/m $\lambda_Q = 1.5$
Design load	= $1.2 \times 45 + 1.5 \times 50 = 129\text{kN/m}$
Vertical design resistance	= 62.2kN (240mm slab 20mm joint)
Therefore centres for vertical load	= $62.2 / 129 = 0.482\text{m}$ use 450mm centres

Each dowel will in addition provide a design resistance across the joint of 100kN (for slab to wall this is 80kN), therefore the total design resistance in the direction of the dowel =  $100 / 0.45 = 222\text{kN}$  (for slab to wall  $80 / 0.45 = 177\text{kN}$ ).

If this is insufficient, the dowel centres can be reduced to a minimum of  $1.5 \times$  slab thickness to increase the design capacity across the joint, in this example it would increase to  $100 / 0.36 = 277\text{kN}$  (for slab to wall  $80 / 0.36 = 222\text{kN}$ ).

#### Joint Filler / Fire Protection

We can provide information on a suitable joint filler and also recommend fire resistant material which could be used as part of an overall fire protection system.

#### Reinforcement Details

Local reinforcement is required around each Ancon Lockable Dowel to guarantee that the forces are transferred between the connectors and the concrete. See page 12 for full details.

## Edge Distance and Spacings

For connectors working at or near their maximum capacity, the minimum spacing should be 1.5 times the slab thickness. Where the design load of the connector could be used in a thinner slab, a spacing of 1.5 times the thinner slab thickness can be used. The minimum end distance is always 0.5 times the spacing.

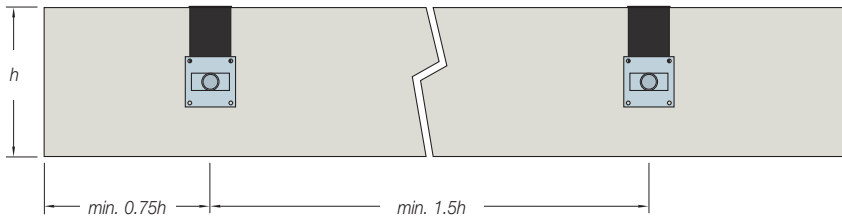

ESDQ-L20 Minimum Edge Distance and Spacings

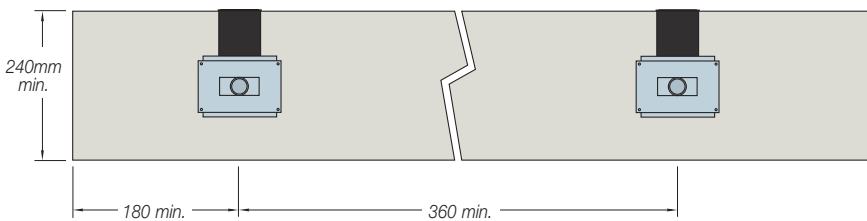

HLDQ-L30 Minimum Edge Distance and Spacings

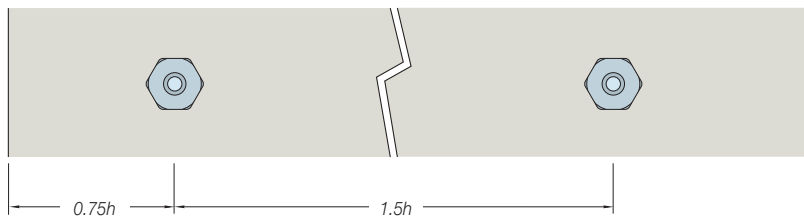

ESDQ-L20W Minimum Edge Distance and Spacings.  $h$  = depth of adjoining slab

### ESDQ-L20 Example

Slab thickness	= 300mm
Maximum width of joint	= 20mm
Concrete strength	= 32MPa
Design resistance/connector	= 63.5kN
(based on slabs 260mm and above)	
Spacing for max. load	$300 \times 1.5 = 450\text{mm}$
End distance for max. load	$450 \times 0.5 = 225\text{mm}$
Design resistance/metre	$= 63.5 / 0.45 = 141.1\text{kN/m}$

As an ESDQ-L20 can be used in a 220mm slab for a design resistance per connector of up to 53.6kN, the spacing can be based on a 220mm slab. Therefore:

Reduced spacing	$220 \times 1.5 = 330\text{mm}$
Reduced end distance	$330 \times 0.5 = 165\text{mm}$
Design resistance/metre	$53.6 / 0.33 = 162.4\text{kN/m}$

# Lockable Dowels and Locking Pins

## Reinforcement Details

Local reinforcement is required around each Ancon Lockable Dowel to guarantee that the forces are transferred between the connectors and the concrete. Correct detailing in accordance with appropriate design codes and the recommendations provided here will ensure the dowels attain their full capacity. The tables show the main reinforcement required, together with details of reinforcement above and below the connectors. Although only the sleeve components are illustrated, the same reinforcement is required around the dowel component.

### Options for Main Reinforcement

Lockable Dowel Ref.	No. of U-bars each side	
	N12	N16
ESDQ-L20	2	-
HLDQ-L30	4	3
ALP19	1*	-

\* L and J bars can be lieu of U-bar for the ALP19

### Options for Longitudinal Reinforcement

Lockable Dowel Ref.	No. of bars top and bottom	
	N12	N16
ESDQ-L20	2	-
HLDQ-L30	2	2
ALP19	3	2

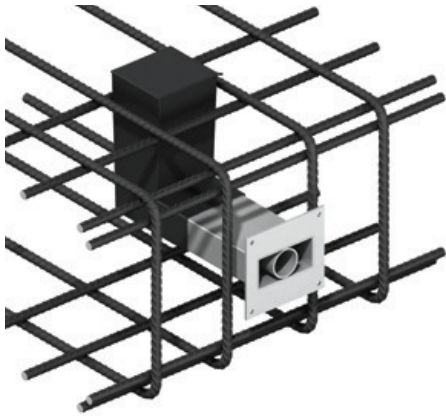

ESDQ-L20

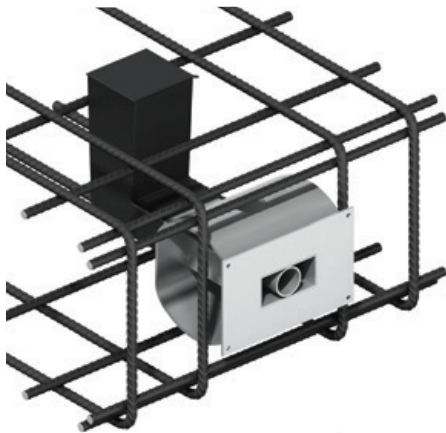

HLDQ-L30

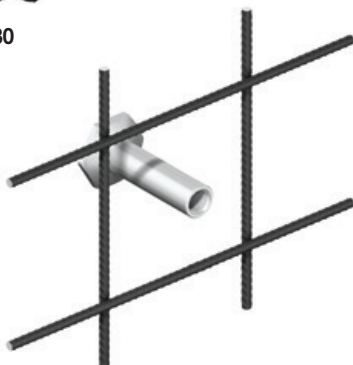

SKS24 Threaded Anchor, part of ESDQ-L20W

### ESDQ-L20

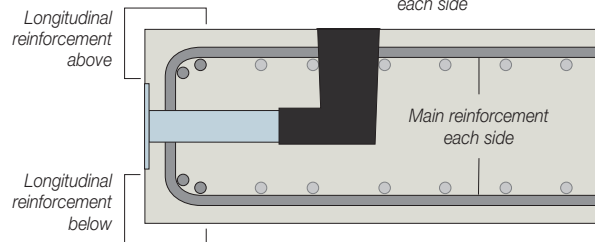
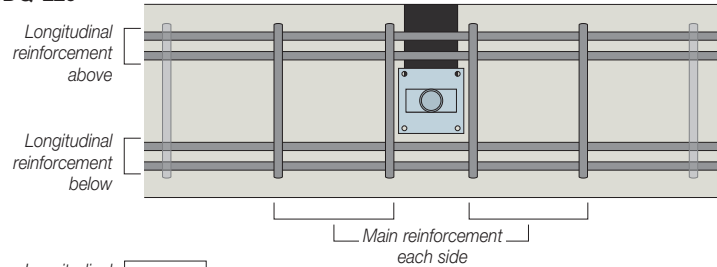

### HLDQ-L30

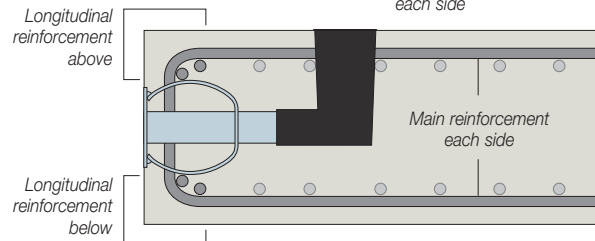
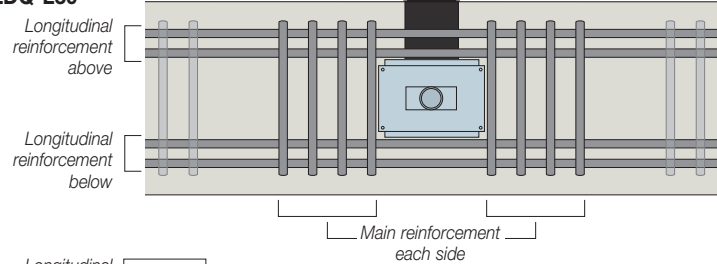

### ALP19

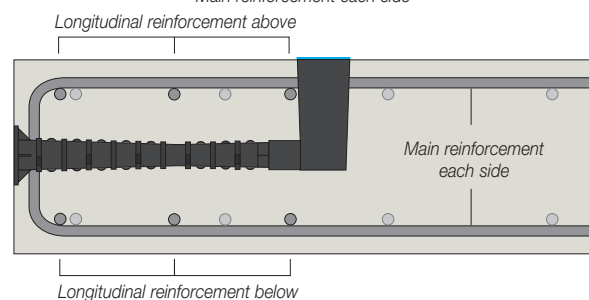
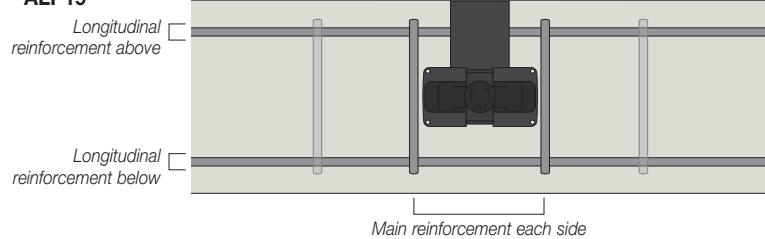

### Threaded Anchor

Reinforcement around the Ancon Threaded Anchor should be a minimum diameter of 12mm, installed at maximum 200mm vertical and horizontal centres.

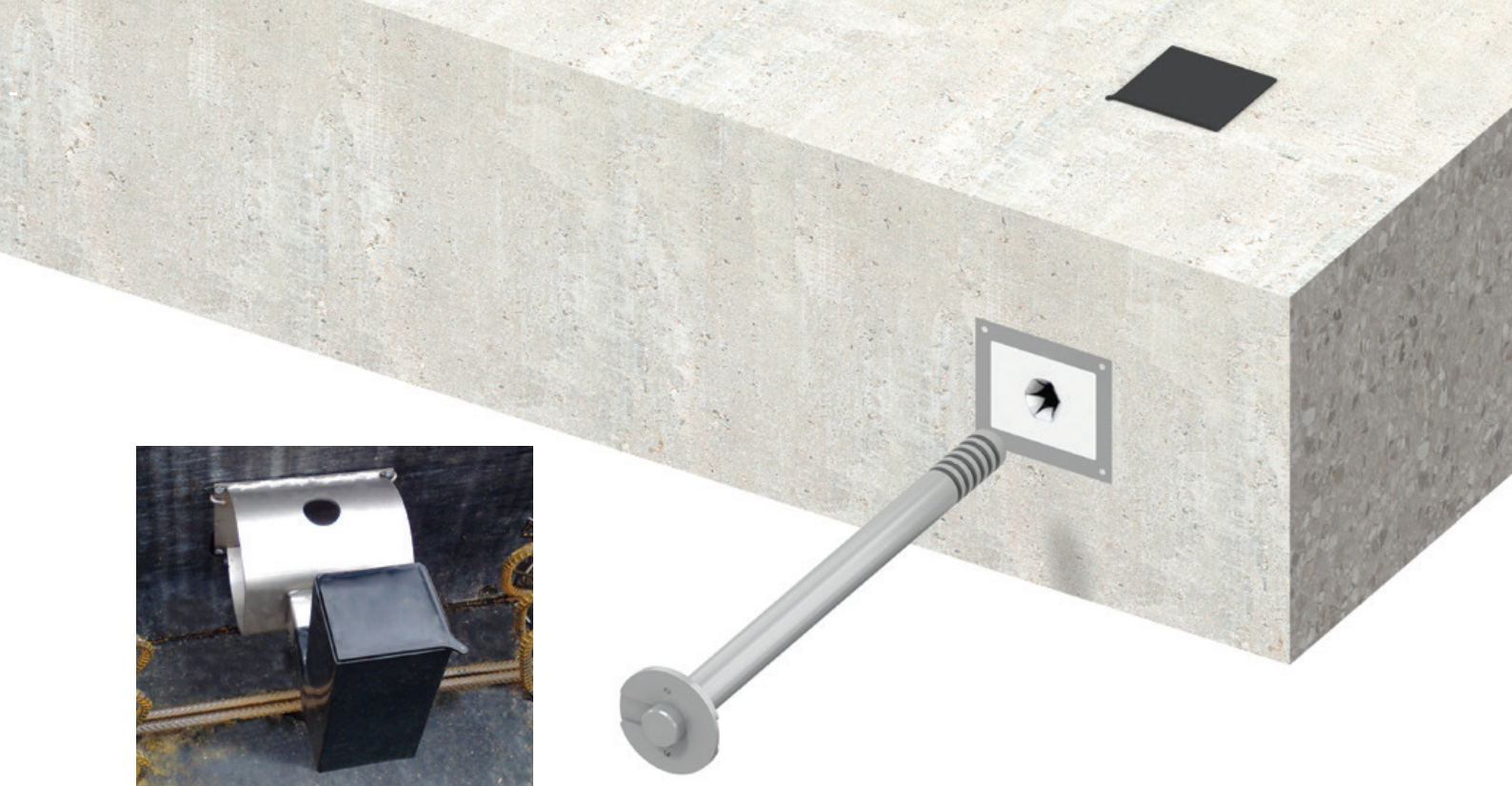

HLDQ-L30 Sleeve Component

## Dimensions

### ESDQ-L20 Components Dowel Component

#### Sleeve Component

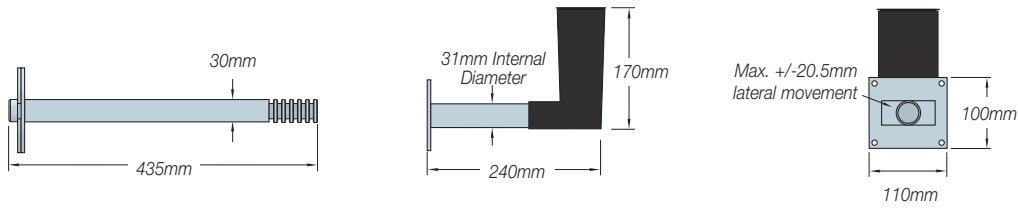

### HLDQ-L30 Components Dowel Component

#### Sleeve Component

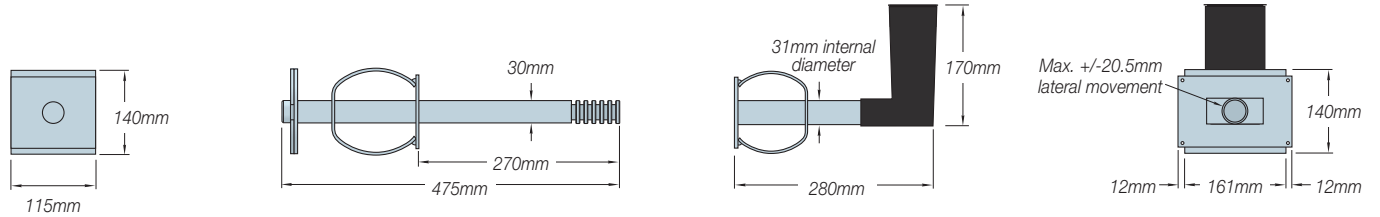

### ESDQ-L20W Components SKS24 Threaded Anchor

#### Dowel Component

#### Sleeve Component

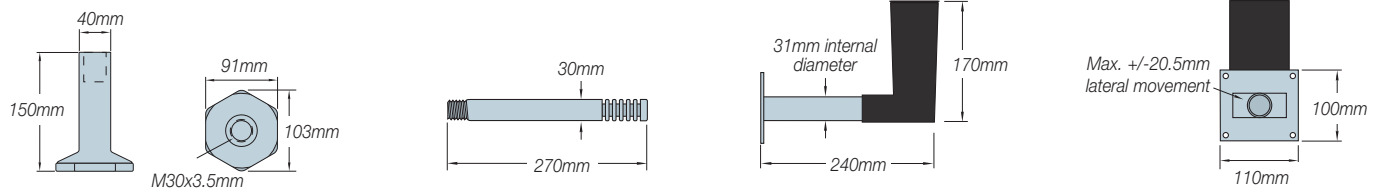

# Lockable Dowels and Locking Pins

## Locking Pin Performance & Dimensions

Locking Pins are ideal for use in applications where tension loads are high but there is little or no shear load or where the shear load is accommodated elsewhere for example either by a support corbel, double column or an alternate Ancon shear load connector.

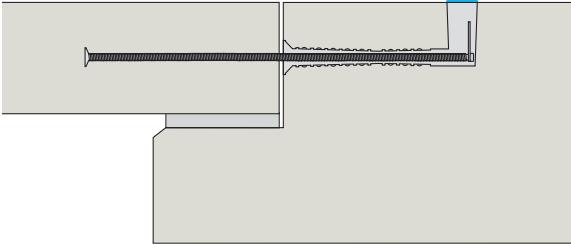

The Ancon Locking Pin offers many advantages over the site-assembled arrangement of carbon steel reinforcing bar, PT ducting, vent tubes and a non-specific grout, which is sometimes used by concrete contractors. Locking Pins are a reliable engineered solution that offers ease of installation and proven performance.

## Dimensions

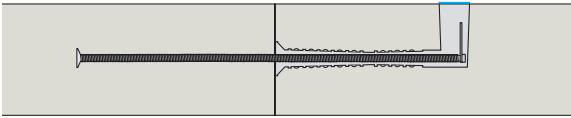

## Independent Testing

Tested at the Centre for Advanced Structural Engineering at the University of Sydney.

The 19mm diameter pin component exceeds the tensile resistance of a standard 16mm reinforcing bar. It offers the added benefit of forming an independently verified, easy-to-install Ancon system.

Product Ref.	Design* Resistance
ALP19	80kN
ALP19W	80kN

*\*min. 180mm slab, min. 32MPa concrete*

## Pin Component

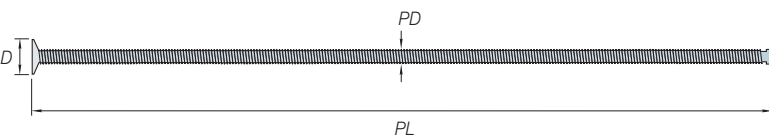

## Sleeve Component

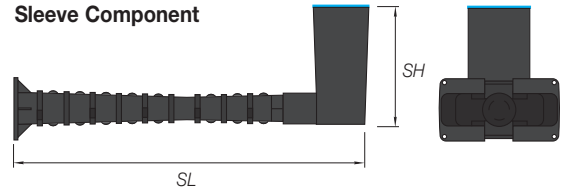

Product Ref.	Stud Head Diameter D	External Pin Diameter PD	Net Cross Sectional Area of pin	Pin Length PL	Sleeve Length SL	Sleeve Height SH	Nailplate	Pin Lateral Movement
ALP19	50mm	19mm	201mm <sup>2</sup>	1000mm	510mm	170mm	180 x 80mm	+/-20mm

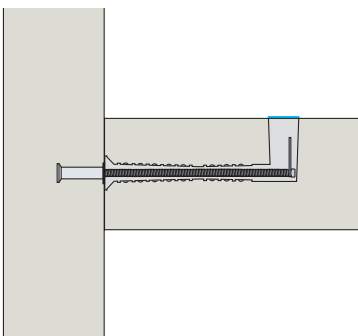

## Threaded Anchor ALP19TA

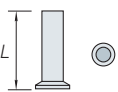

## Pin Component

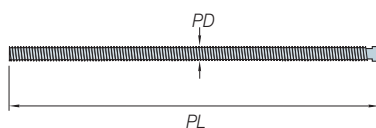

## Sleeve Component

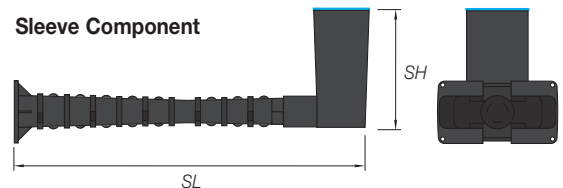

Product Ref.	Anchor Length L	External Pin Diameter PD	Net Cross Sectional Area of pin	Pin Length PL	Sleeve Length SL	Sleeve Height SH	Nailplate	Pin Lateral Movement
ALP19W	150mm	19mm	215mm <sup>2</sup>	543mm	506mm	170mm	180x80mm	+/-20mm

## Installation: Lockable Dowels

### Slab-to-Slab

Although installation is shown for the ESDQ-L20, the procedure is the same for the HLDQ-L30.

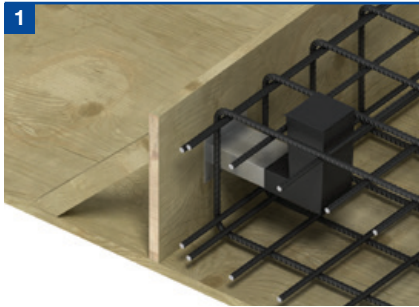

Nail the sleeve to the formwork either central in the slab or for slab depths over 300mm so the top of the void former is level with the top of the slab. Do not remove the label over the nailing plate as this prevents ingress of concrete into the sleeve. Fix the local reinforcement, as specified on engineer's drawings.



Pour the concrete, and when of sufficient strength, strike the formwork. Puncture the label to reveal the cylindrical sleeve only and insert the dowel until it is approximately 20mm from the back of the void former.

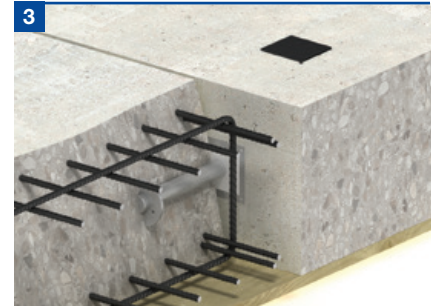

Fix the local reinforcement around the dowel component and pour the concrete.

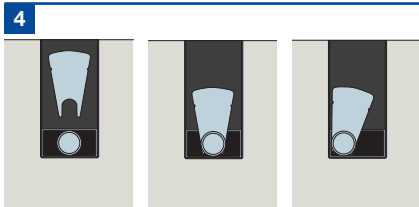

After a predetermined time period (generally 3-4 weeks), when movement between the slabs has stabilised and the joint between the slabs has been filled, the dowel is ready to be locked.

Fit the Locking Plate on a groove in the centre of the void former. The fan-shaped Locking Plate allows the dowel to be locked in any position.



Mix the two-part epoxy resin and pour into the void former. It is essential the resin flows along the stainless steel box section towards the joint and reaches the notches on the locking plate, which indicate minimum resin depth. Joint must be filled before resin is installed.



After 24 hours the void former can be filled with cementitious material, level with the top of the slab, to complete the installation.

The locked dowel continues to transfer vertical load between the slabs, but movement can no longer take place.

### Slab-to-Wall

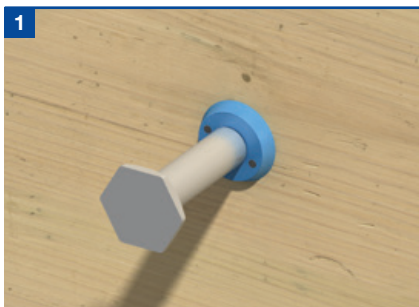

Nail the threaded anchor to the formwork so the dowel will be central in the adjoining slab or within 150mm of the top of slabs over 300mm. Fix the local reinforcement as specified on engineer's drawings and cast the concrete.

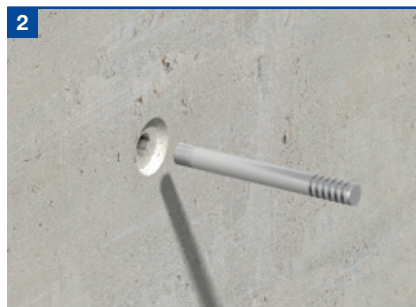

When concrete reaches sufficient strength, strike the formwork and remove nailing plate. Screw the dowel into the anchor.

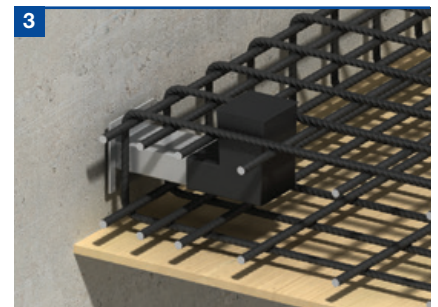

Puncture the label of the sleeve to reveal the cylindrical sleeve only. Push the sleeve over the dowel until it is flush with the concrete. Tie sleeve to reinforcement and pour concrete.

See Steps 4 to 6 above to complete installation.

**Notes:** Where deep concrete pours are proposed, the installation will require further consideration. More robust fixing of the sleeve and dowel components will be necessary, to avoid displacement during casting of the concrete.



# Lockable Dowels and Locking Pins

## Installation: Locking Pin

Locking Pins provide many advantages over a site-assembled arrangement of carbon steel reinforcing bar, PT ducting, vent tubes and a non-specific grout, including ease of installation and proven performance.

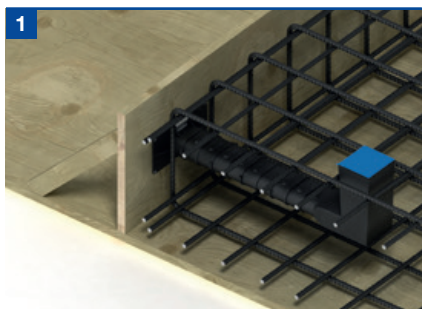

Nail the sleeve to the formwork either central in the slab or for slab depths over 300mm so the top of the void former is level with the top of the slab. Do not remove the label over the nailing plate as this prevents ingress of concrete into the sleeve. Fix the local reinforcement.

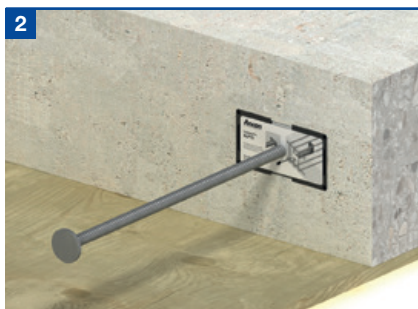

Pour the concrete, and when of sufficient strength, strike the formwork. Puncture the label to reveal the cylindrical sleeve only and insert the pin until it is approximately 10mm from the back of the void former.



Fix the local reinforcement. Tie the pin to the local reinforcement for additional support and pour the concrete.

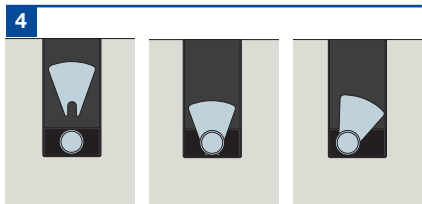

After a predetermined time period (generally 90-120 days) when movement between the slabs has stabilised and the joint between the slabs has been filled, the pin is ready to be locked. Fit the Locking Plate on the groove at the end of the pin in the void former. The fan-shaped Locking Plate allows the pin to be locked in any position.



Mix the grout using a mechanical mixer (refer to separate installation instructions on grout packaging) and pour into the void former, ensuring it flows along the box section towards the joint, until level with the top of the slab. Joint must be filled before grout is installed.



After 24 hours, check the void former is fully filled level with the top of the slab, top up with more of the cementitious grout material if required, to complete the installation.

## Slab-to-Wall



Nail the Anchor to the formwork so the pin will be central in the adjoining slab or within 150mm of the top of slabs over 300mm. Fix the local reinforcement as specified on engineer's drawings and cast the concrete.



When concrete reaches sufficient strength, strike the formwork and remove nailing plate. Screw the pin into the anchor.

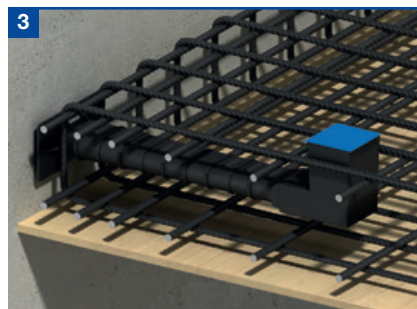

Puncture the label of the sleeve to reveal the cylindrical sleeve only. Push the sleeve over the pin until it is flush with the concrete. Tie sleeve to reinforcement and pour concrete.

See Steps 4 to 6 above to complete installation.



## Project References



5,000 Lockable dowels were installed on the Royal Children's Hospital, Melbourne, VIC



2,500 Lockable dowels were installed on the Supreme & District Court, Brisbane, QLD



500 Lockable dowels were installed on the Emergency Care Centre in Aberdeen, UK

## Other Ancon Products

### DSD/Q Shear Load Connectors

Ancon DSD and DSDQ double-dowel connectors are used to transfer shear across movement joints in suspended concrete slabs. They are more effective at transferring load and allowing movement than standard single dowels and can be used to eliminate double columns at structural movement joints in buildings. The Q version features a rectangular box section to allow lateral and some rotational movement.

### Plate Dowel Systems

Ancon MultiJoint is a plate dowel system for use in ground bearing concrete floor slabs. It is an all-in-one solution to load transfer, concrete contraction, armoured edge protection and formwork. Individual plate dowels are also available.

### Punching Shear Reinforcement

Ancon Shearfix is used within a slab to provide additional reinforcement from punching shear around columns. The system consists of double-headed steel studs welded to flat rails and is designed to suit the load conditions and slab depth at each column using our free calculation software.

### Reinforcing Bar Couplers

The use of reinforcing bar couplers can provide significant advantages over lapped joints. Design and construction of the concrete can be simplified and the amount of reinforcement can be reduced. The Ancon range includes BT parallel-threaded and MBT mechanically-bolted couplers.

### Reinforcement Continuity Systems

Reinforcement Continuity Systems are an increasingly popular means of maintaining continuity of reinforcement at construction joints in concrete. The Ancon Keybox system eliminates the need to drill shuttering and can simplify formwork design, thereby accelerating the construction process. It is available in both standard units and special configurations. Ancon KSN Anchors eliminate the need for on-site bar straightening and are available as standard to accept 12mm, 16mm and 20mm diameter rebar. The system is also available with a re-useable rebate former.

### Stainless Steel Reinforcement

Leviat supplies stainless steel plain and ribbed bar in a variety of grades, including high proof strength material, direct from stock. Bar diameters range from 6mm to 50mm and can be cut to length, bent and threaded to suit any application. Stainless steel BT couplers are also available to suit bars from 12mm diameter.



## Worldwide contacts for Leviat:

### Australia

**Leviat**  
98 Kurrajong Avenue,  
Mount Druitt Sydney, NSW 2770  
Tel: +61 - 2 8808 3100  
Email: info.au@leviat.com

### Austria

**Leviat**  
Leonard-Bernstein-Str. 10  
Saturn Tower, 1220 Wien  
Tel: +43 - 1 - 259 6770  
Email: info.at@leviat.com

### Belgium

**Leviat**  
Industrielaan 2  
1740 Ternat  
Tel: +32 - 2 - 582 29 45  
Email: info.be@leviat.com

### China

**Leviat**  
Room 601 Tower D, Vantone Centre  
No. A6 Chao Yang Men Wai Street  
Chaoyang District  
Beijing · P.R. China 100020  
Tel: +86 - 10 5907 3200  
Email: info.cn@leviat.com

### Czech Republic

**Leviat**  
Business Center Šafránková  
Šafránková 1238/1  
155 00 Praha 5  
Tel: +420 - 311 - 690 060  
Email: info.cz@leviat.com

### Finland

**Leviat**  
Vädursgatan 5  
412 50 Göteborg / Sweden  
Tel: +358 (0)10 6338781  
Email: info.fi@leviat.com

### France

**Leviat**  
6, Rue de Cabanis  
FR 31240 L'Union  
Toulouse  
Tel: +33 - 5 - 34 25 54 82  
Email: info.fr@leviat.com

### Germany

**Leviat**  
Liebigstrasse 14  
40764 Langenfeld  
Tel: +49 - 2173 - 970 - 0  
Email: info.de@leviat.com

### India

**Leviat**  
309, 3rd Floor, Orion Business Park  
Ghodbunder Road, Kapurbawdi,  
Thane West, Thane,  
Maharashtra 400607  
Tel: +91 - 22 2589 2032  
Email: info.in@leviat.com

### Italy

**Leviat**  
Via F.lli Bronzetti 28  
24124 Bergamo  
Tel: +39 - 035 - 0760711  
Email: info.it@leviat.com

### Malaysia

**Leviat**  
28 Jalan Anggerik Mokara 31/59  
Kota Kemuning, 40460 Shah Alam  
Selangor  
Tel: +603 - 5122 4182  
Email: info.my@leviat.com

### Netherlands

**Leviat**  
Oostermaat 3  
7623 CS Borne  
Tel: +31 - 74 - 267 14 49  
Email: info.nl@leviat.com

### New Zealand

**Leviat**  
2/19 Nuttall Drive, Hillsborough,  
Christchurch 8022  
Tel: +64 - 3 376 5205  
Email: info.nz@leviat.com

### Norway

**Leviat**  
Vestre Svanholmen 5  
4313 Sandnes  
Tel: +47 - 51 82 34 00  
Email: info.no@leviat.com

### Philippines

**Leviat**  
2933 Regus, Joy Nostalg,  
ADB Avenue  
Ortigas Center  
Pasig City  
Tel: +63 - 2 7957 6381  
Email: info.ph@leviat.com

### Poland

**Leviat**  
Ul. Obornicka 287  
60-691 Poznan  
Tel: +48 - 61 - 622 14 14  
Email: info.pl@leviat.com

### Singapore

**Leviat**  
14 Benoi Crescent  
Singapore 629977  
Tel: +65 - 6266 6802  
Email: info.sg@leviat.com

### Spain

**Leviat**  
Poligono Industrial Santa Ana  
c/ Ignacio Zuloaga, 20  
28522 Rivas-Vaciamadrid  
Tel: +34 - 91 632 18 40  
Email: info.es@leviat.com

### Sweden

**Leviat**  
Vädursgatan 5  
412 50 Göteborg  
Tel: +46 - 31 - 98 58 00  
Email: info.se@leviat.com

### Switzerland

**Leviat**  
Grenzstrasse 24  
3250 Lyss  
Tel: +41 - 31 750 3030  
Email: info.ch@leviat.com

### United Kingdom

**Leviat**  
President Way, President Park,  
Sheffield, S4 7UR  
Tel: +44 - 114 275 5224  
Email: info.uk@leviat.com

### United States of America

**Leviat**  
6467 S Falkenburg Rd.  
Riverview, FL 33578  
Tel: (800) 423-9140  
Email: info.us@leviat.us

### For countries not listed

Email: info@leviat.com

**Leviat.com**

#### Notes regarding this catalogue

© Protected by copyright. The construction applications and details provided in this publication are indicative only. In every case, project working details should be entrusted to appropriately qualified and experienced persons. Whilst every care has been exercised in the preparation of this publication to ensure that any advice, recommendations or information is accurate, no liability or responsibility of any kind is accepted by Leviat for inaccuracies or printing errors. Technical and design changes are reserved. With a policy of continuous product development, Leviat reserves the right to modify product design and specification at any time.

**For more information on the following products, please contact:**

**Masonry, Structural and  
Precast Concrete products:**

1300 304 320  
info.ancon.au@leviat.com  
Ancon.com.au

**Concrete Floor Jointing  
products:**

1800 335 215  
info.connolly.au@leviat.com  
Connollykeyjoint.com  
info.isedio.au@leviat.com  
Isedio.com.au

**Remedial Masonry  
products:**

1300 667 071  
info.helifix.au@leviat.com  
Helifix.com.au

**General Enquiries**

1300 304 320  
Leviat.com

**Sales Offices and Production**

**New South Wales, Sydney**

98 Kurrajong Avenue  
Mount Druitt | Sydney  
NSW 2770

**New South Wales, Casino**

10 Irving Drive  
Casino  
NSW 2470

**Victoria**

9/63-69 Pipe Road  
Laverton North | Melbourne  
VIC 3026

**Queensland**

4/15 Terrace Place  
Murarrie | Brisbane  
QLD 4172

**Western Australia**

18 Tennant Street  
Welshpool | Perth  
WA 6106

**Leviat.com**

---

**Leviat**<sup>®</sup>  
A CRH COMPANY

**Imagine. Model. Make.**

**Leviat.com**