

Leviat[®]
A CRH COMPANY

HALFEN

FIXING TECHNOLOGY LIFTS AND ELEVATORS
With us to the very top: product application





We are one team. **We are Leviat.**

Leviat is the new name of CRH's construction accessories companies worldwide.

Under the Leviat brand, we are uniting the expertise, skills and resources of HALFEN and its sister companies to create a world leader in fixing, connecting and anchoring technology.

The products you know and trust, including HALFEN Fixing technology, will remain an integral part of Leviat's comprehensive brand and product portfolio. As Leviat, we can offer you an extended range of specialist products and services, greater technical expertise, a larger and more agile supply chain and better, faster innovation.

By bringing together CRH's construction accessories family as one global organisation, we are better equipped to meet the needs of our customers, and the demands of construction projects, of any scale, anywhere in the world.

This is an exciting change. Join us on our journey.

Read more about Leviat at [Leviat.com](https://www.leviat.com)



Our product brands include:

Ancon[®]

HALFEN

PLAKA



60

locations

sales in
30+
countries

3000

people worldwide

Imagine. Model. Make.

Leviat.com





SAFETY

you can rely on!

Not content on just being good, but always striving to be better; we have continuously developed and optimized our **anchoring, reinforcement and framing technology** products. Success when using HALFEN products proves we are on the right track. When it comes to connections for the construction industry, one thing is especially important: **Quality!**

This applies especially to elevator construction; safe and adjustable fixtures in the lift shaft for installation and during maintenance are essential; and vital for **personal safety**. Good that you can rely on tried and tested quality; our products for elevator construction ensure your projects stay safe!

This brochure illustrates applications of **HALFEN Cast-in and framing channels** as well as the **HALFEN Lift-Box** in elevator construction. We show how you can optimize planning your project with effective use of HALFEN Products!

PAGE

4

6

8

12

16

18

21

Contents

WHAT'S IN A LIFT SHAFT?

YOUR ADVANTAGES WITH US

CAST-IN CHANNELS AND BOLTS

FRAMING CHANNELS AND BOLTS

ATTACHMENT POINTS

YOUR BIM PARTNER

CONTACT

Did you know?

Our products can be used in concrete, masonry and steel shafts.

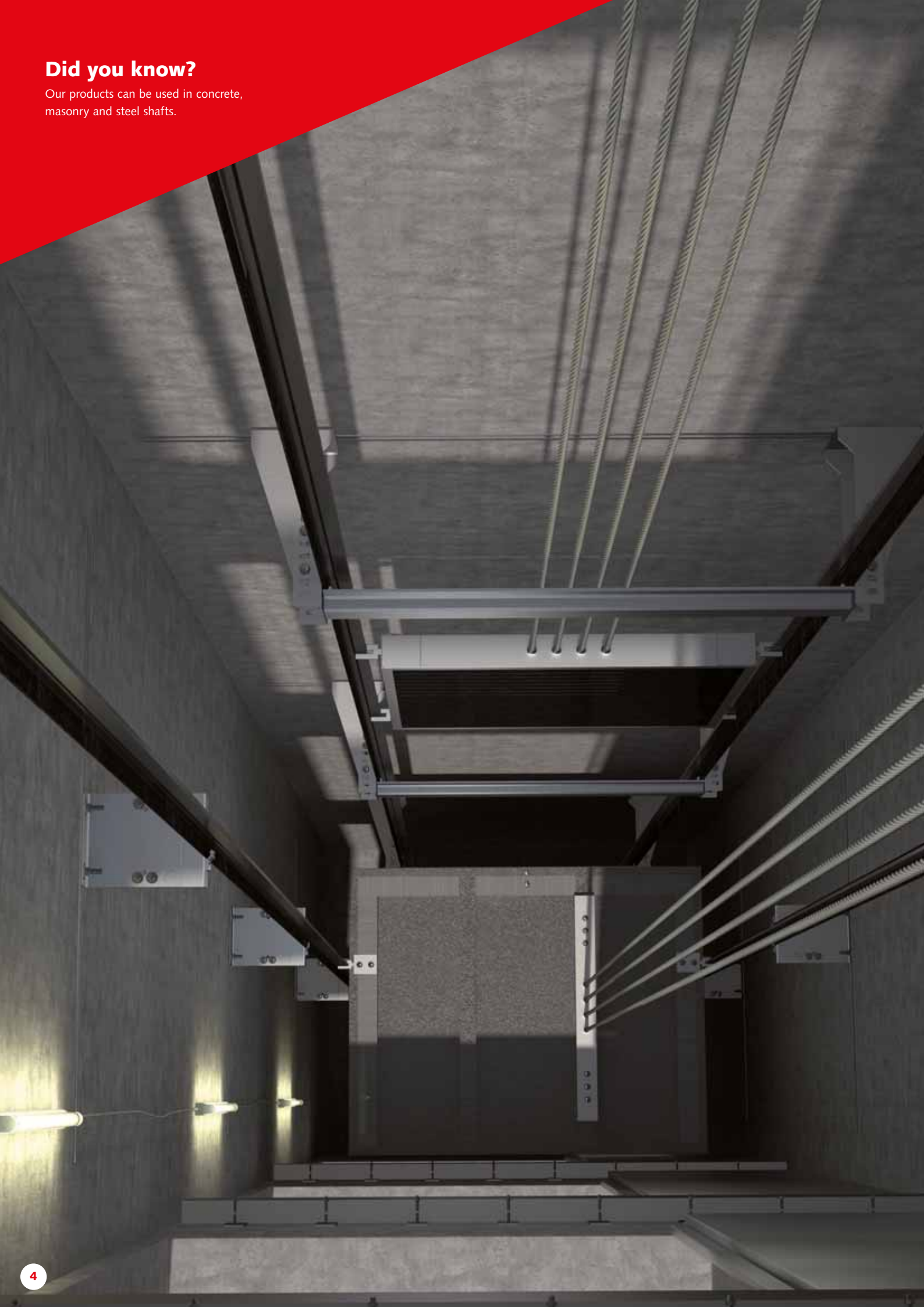

WHAT'S IN A LIFT SHAFT?

Safe and reliable anchorage is essential for installation or maintenance work in lift shafts: Quality is also decisive. You won't just find our product portfolio here, but also see typical applications of where our products are used in lift shafts.



HALFEN HLX-Lift-Box – Cast into the concrete slab at the top of a shaft



The attachment point is used to secure loads during initial installation and subsequent maintenance work



Cast-in channels and bolts



Cast-in channels to fix guide rails, doors and attachment points



Framing channels and bolts



Framing channels for welding or dowel and bolt fixing; for connection of steel components such as lift guide rails, handrails, guard rails, and control units.

From planning to the finished lift: **YOUR ADVANTAGES WITH US**

- › Pre-planning with Cast-in channels for quick installation
- › Quick, efficient installation reduces costs
- › Dust free installation, no on-site drilling or doweling required
- › Safety against fatigue related failure
- › High quality products using high quality steel





© Klaus Steinweg (all pictures on this page)

1 2 3 4 5 6 7 8 9

Cast-in channels

- › Efficient installation and adjustment
- › Cost effective, economic solution
- › Reliable quality
- › Versatile application
- › Reliable connection

OVERVIEW:

HALFEN Cast-in channels

With HALFEN Cast-in channels you can select the channel profile as required. Hot-rolled HALFEN Channel, either toothed or smooth, are suitable for dynamic loads, and cold-rolled channels are the right choice for pre-dominantly static loads and for lower demands. Our Software can dimension all channels for any situation in advance to facilitate planning and to shorten overall construction time and therefore reduce costs.

The main load bearing reinforcement is not compromised by the Cast-in channel. Further major benefits are the adjustable anchorage and the simple installation using bolts and simple tools, which helps to reduce costs. The following pages illustrate the channel profiles relevant for elevator construction.

The solution for high loads: Hot-rolled Cast-in channels for guide rails



HALFEN Channels HTA-CE hot-rolled, smooth

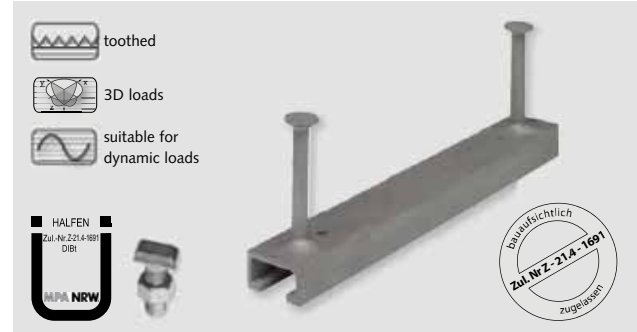

HALFEN Channels HZA hot-rolled, toothed

Facilitates planning due to load distribution in all directions (3D load distribution)

HALFEN Bolts for Cast-in channels

A combination of channels and the tried and tested HALFEN Bolts provide maximum reliability



HALFEN HS Bolts

Suitable for all smooth framing channels. For loads in two directions.



HALFEN HZS Bolts

Suitable for toothed framing channels. Positive load transfer also in channel longitudinal direction.



What does HTA-CE involve?

HTA-CE signifies that the channel is CE marked. We as the manufacturer and compliance with all relevant European legislation has been applied. declares, that it is responsible for the conformity of the product with the (DoP – Declaration of performance), and that the specified performance

HOT-ROLLED CAST-IN CHANNELS: KEY VALUES HTA-CE

Typical application in elevator construction	Attachment points			Guide rail fixing		
Profile	HTA-CE 55/42	HTA-CE 52/34	HTA-CE 50/30P	HTA-CE 50/30	HTA-CE 40/22P	HTA-CE 40/22
Dimensions HALFEN HTA-CE Channels			NEW 		NEW 	
Material	Steel	■	■	■	■	■
	A4	■	■	■	■	■
Bolts	HS 50/30	HS 50/30	HS 50/30	HS 50/30	HS 40/22	HS 40/22
Thread	M10 - M20	M10 - M20	M10 - M20	M10 - M20	M10 - M16	M10 - M16
N_{Rd} [kN] / V_{Rd} [kN]	44.4/61.1	30.6/43.3	21.7/32.8	17.2/28.9	16.1/19.4	11.1/19.4
Suitable for fatigue related tension loads.	✓	✓	✓	✓	✓	✓

NEW



THE HALFEN CHANNELS WITH EXTRA LOAD CAPACITY

Features overview:



> CE marking with European Technical Assessment



> hot-rolled HALFEN Channels



> up to 45% higher load capacities



> suitable for dynamic loads



> high fire resistance



> planning with our Software

HOT-ROLLED TOOTHED CAST-IN CHANNELS: KEY VALUES HZA

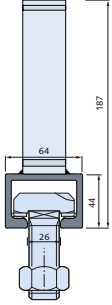
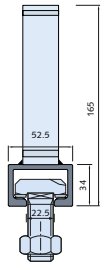
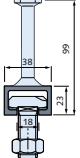
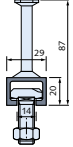
Typical application in elevator construction	Lift, guide rail fixing for loads in channel longitudinal direction.			
Profile	HZA 64/44 DYNAGRIP	HZA 53/34 DYNAGRIP	HZA 38/23 DYNAGRIP	HZA 29/20 DYNAGRIP
Hot-rolled				
Dimensions HALFEN HZA Channels				
Material	Steel	■	■	■
	A4	■	■	■
Bolts	HZS 64/44	HZS 53/34	HZS 38/23	HZS 29/20
Thread	M20 + M24	M16 + M20	M12 + M16	M12
F_{Rd}	37.8 kN All load directions	30.8 kN All load directions	16.8 kN All load directions	11.2 kN All load directions
Suitable for fatigue related tension loads.	✓	✓	✓	✓

COLD-ROLLED CAST-IN CHANNELS: KEY VALUES

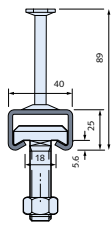
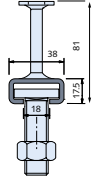
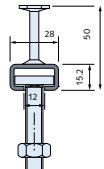
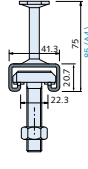
Profile	HTA-CE 40/25	HTA-CE 38/17	HTA-CE 28/15	HZA 41/22
Dimensions HALFEN HTA-CE Channels				
Material	Steel	■	■	■
	A4	■	■	■
Bolts	HS 40/22	HS 38/17	HS 28/15	HZS 41/22
Thread	M10 - M16	M10 - M16	M6 - M12	M12 - M16
N_{Rd} [kN]/ V_{Rd} [kN]	11.1	10.0	5.0	7.0 kN All load directions
Suitable for fatigue related tension loads.	✗	✗	✗	✗



1 2 3 4 5 6 7 8 9

FRAMING CHANNELS

- › Free positioning and dimensioning
- › Fine adjustment in seconds
- › Cost reduction due to high level of standardization of the versatile bolt connections



WIDE SELECTION OF CHANNELS:

HALFEN Framing channels

For fixing guard rails, doors and control units we have a wide range of framing channels, available for weld-on, bolt-on or for dowel fixing. On the following pages you will find a selection of our framing channels, which are especially suited for use in elevator construction.

For dynamic loads we provide the hot-rolled HALFEN Channel, either toothed or smooth, and the cold-rolled channels are the right choice for pre-dominantly static loads.

The solution for very high loads and dynamic loads: Hot-rolled framing channels



Framing channels HM, hot-rolled, smooth
For approved longitudinal loads of up to F_{app} = up to 7.5 kN



Framing channels HZM, hot-rolled, toothed
For high longitudinal loads F_{app} = up to 27 kN

With holes or without holes for low loads: Cold-rolled framing channels



Framing channels HL, HM, cold-rolled, smooth



Framing channels HZL, HZM, cold-rolled, toothed

HALFEN Bolts for framing channels

The framing channels used in combination with HALFEN Bolts provide a versatile bolt connection



HALFEN HS Bolts

Suitable for all smooth framing channels. For loads in two directions.



HALFEN HSR Bolts

Only for hot-rolled carbon steel framing channels. Nibbed non-slip bolt. For loads in all directions.



HALFEN HZS Bolts

Suitable for toothed framing channels. Positive load transfer also in channel longitudinal direction.

CE marking EN 1090-1, EN 1090-2 for all hot-rolled framing channels

What does HTA-CE involve?

HTA-CE signifies that the channel is CE marked. We as the manufacturer declares, that it is responsible for the conformity of the product with the (DoP – Declaration of performance), and that the specified performance and compliance with all relevant European legislation has been applied.

HOT-ROLLED FRAMING CHANNELS

HEAVY DUTY FRAMING SYSTEM

Product	HM 72/48	HM 55/42	HM 52/34	HM 50/30	HM 40/22
Article name	HS 72/48, HSR 72/48	HS 50/30	HS 50/30, HSR 50/30		HSR 40/22 HS 40/22

HOT-ROLLED TOOTHED FRAMING CHANNELS – HEAVY DUTY FRAMING SYSTEM

Product	HZM 64/44	HZM 53/34	HZM 41/27	HZM 38/23	HZM 29/20
Article name	HZS 64/44	HZS 53/34	HZS 38/23	HZS 38/23, HS 38/17	HZS 29/20, HS 28/15

MATERIALS AND FINISHES

FV hot-dip galvanized or WB mill finished

A4 stainless steel 1.4571/1.4404

A2 stainless steel 1.4307

HZM / HZL toothed profile

COLD-ROLLED FRAMING CHANNELS

HEAVY DUTY FRAMING SYSTEM

Product

HM 49/30



HM 40/25

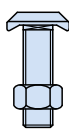
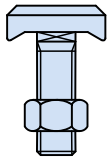
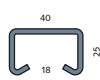
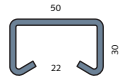
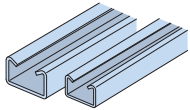

Article name

HS 50/30

HS 40/22, HSR 40/22

LIGHT DUTY FRAMING SYSTEM

Product

HM 38/17



HM 28/15, HL 28/15

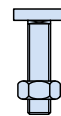
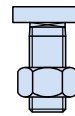
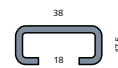

Article name

HS 38/17

HS 28/15



Versatile application:

FRAMING CHANNELS IN ELEVATOR CONSTRUCTION

HALFEN Framing channels are a flexible and adjustable solution for numerous types of fixing situations in elevator construction - for example: fixings directly to the lift car and for fixing the doors.

Attachment points

- › For lift and fall protection equipment
- › Effective fixing even at great heights
- › Dependable quality

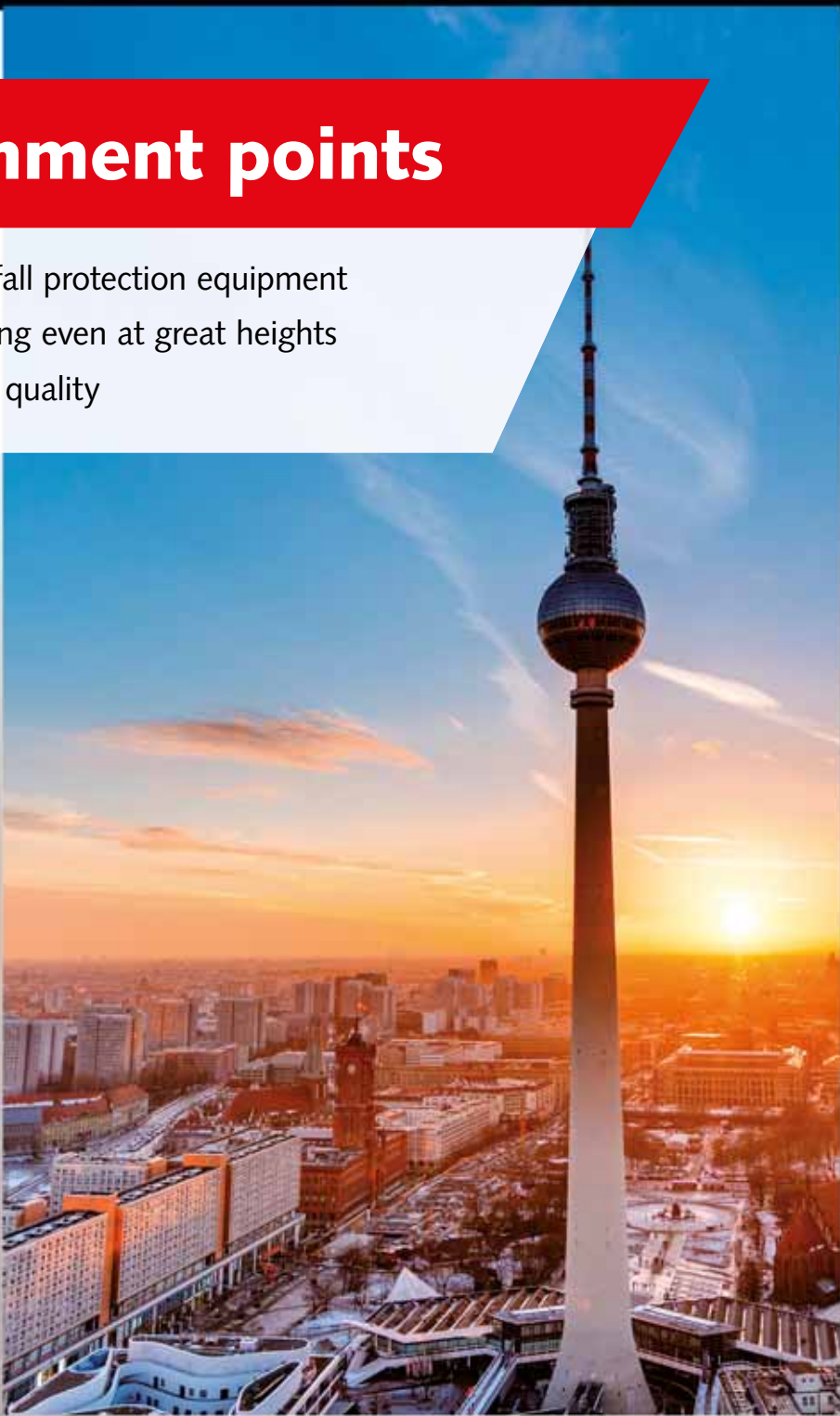

HALFEN HLX LIFT-BOX

The HALFEN Lift-Box is an auxiliary aid for the installation and maintenance of lifts. It ensures a safe, temporary fixing point when working on the lift. It is set in the concrete as an anchor point on the shaft ceiling. Even heavy lift equipment can be temporarily attached.

Product Range

The HALFEN HLX Lift-Box is delivered to site as a complete pre-assembled unit.



HALFEN HLX Lift-Box with attachment point: Chain-link automatic release and self-locking or with wire cable loop

The most important features and benefits at a glance:

- > High load capacity (1500 kg, 2000 kg, 4000 kg)
- > CE marking in compliance with ETA European Technical Assessment
- > Modern plastic design
- > Execution with loop and chain-link
- > Automatic release and self-locking chain-link
- > Easy to fold back
- > Protection against twisting
- > Complete pre-assembled unit.
- > Quick and easy to install
- > Usable for minimum slab thickness of 150 mm due to small edge distances
- > Detailed, multilingual installation and usage instructions
- > CAD Data

Certificates

- > European Technical Assessment ETA-17/0488
- > CE marking in compliance with ETA 

Technical Data

- > Load classes 1500 kg, 2000 kg, 4000 kg

HALFEN PSA ATTACHMENT POINT

for personal fall protection equipment

The attachment point for personal fall protection (PSA) is complemented with an approved stainless steel DEMU T-FIXX[®], Fixing anchor, an identification cap and an attachment hook. The suitability of the approved DEMU T-FIXX[®] Fixing anchor was proven in a DGUV test based on CEN/TS 16415.



Building Information Modeling: **YOUR BIM PARTNER**

HALFEN product and detailing plans created by our engineers for your projects are also provided as BIM (Building Information Modeling) CAD files to generate a 3D model of your building. Using BIM software for the design, construction process and maintenance of a building makes it much easier for architects, builders and suppliers

to coordinate all aspects of a project. All information relevant to a building is made available in one place. Problems between various building disciplines can be quickly checked. All involved parties are able to cooperate more effectively resulting in real time and cost saving.



We can provide the CAD files for your BIM project:

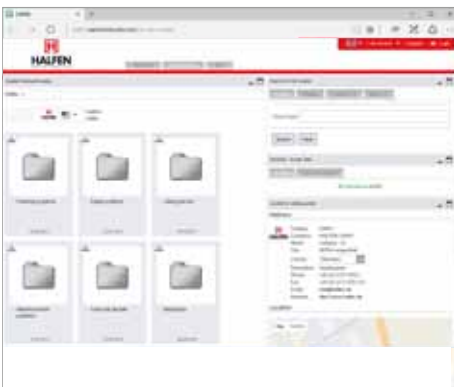

HALFEN PARTcommunity, The **CAD-Portal**



TEKLA®-Software building component library

digipara®
liftdesigner

BIM files for HALFEN Channels can also be found in DigiPara®-Liftdesigner program.



VISIT THE HALFEN CAD-PORTAL:

free, international and versatile with numerous 2D and 3D downloadable files!

Easy to calculate – safe planning:

SOFTWARE FOR HALFEN CAST-IN CHANNELS

Our Software is a easy-to-use, powerful tool for calculation and design of HALFEN Channels. The program is easy to use and intuitive, it provides all necessary calculations and verifications for channels for a specified load situation in a matter of seconds. Further tools, catalogues and installation instructions can be found online at www.halfen.com.

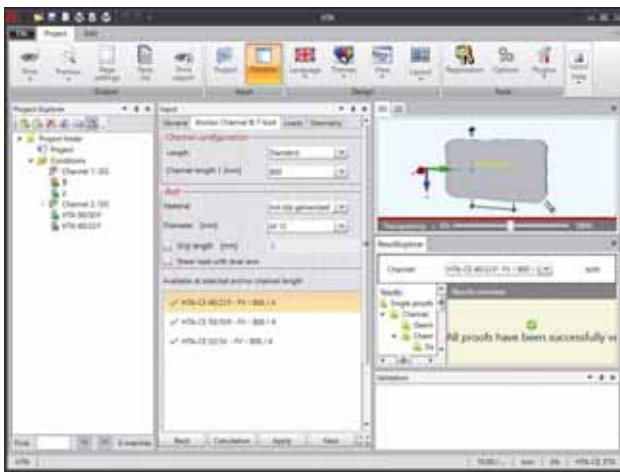

HALFEN HTA-CE Software; input screen

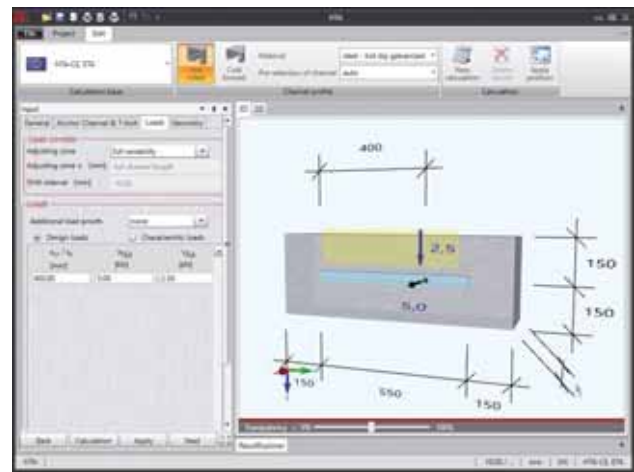

Interactive 3D display

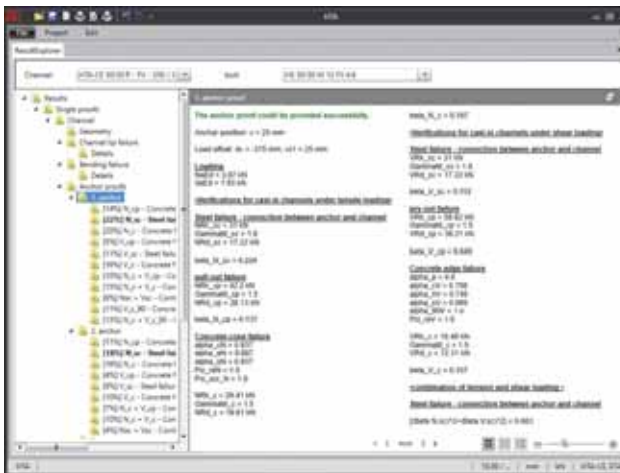

The result in a listbox



Further tools are available at www.halfen.com

- Catalogues
- CAD drawings
- Installation instructions
- Videos



Leviat[®]
A CRH COMPANY

Innovative engineered products and construction solutions that allow the industry to build safer, stronger and faster.



Worldwide contacts for Leviat:

Australia

Leviat
98 Kurrajong Avenue,
Mount Druitt Sydney, NSW 2770
Tel: +61 - 2 8808 3100
Email: info.au@leviat.com

Austria

Leviat
Leonard-Bernstein-Str. 10
Saturn Tower, 1220 Wien
Tel: +43 - 1 - 259 6770
Email: info.at@leviat.com

Belgium

Leviat
Borkelstraat 131
2900 Schoten
Tel: +32 - 3 - 658 07 20
Email: info.be@leviat.com

China

Leviat
Room 601 Tower D, Vantone Centre
No. A6 Chao Yang Men Wai Street
Chaoyang District
Beijing · P.R. China 100020
Tel: +86 - 10 5907 3200
Email: info.cn@leviat.com

Czech Republic

Leviat
Business Center Šafránková
Šafránková 1238/1
155 00 Praha 5
Tel: +420 - 311 - 690 060
Email: info.cz@leviat.com

Finland

Leviat
Vädursgatan 5
412 50 Göteborg / Sweden
Tel: +358 (0)10 6338781
Email: info.fi@leviat.com

France

Leviat
18, rue Goubet
75019 Paris
Tel: +33 - 1 - 44 52 31 00
Email: info.fr@leviat.com

Germany

Leviat
Liebigstrasse 14
40764 Langenfeld
Tel: +49 - 2173 - 970 - 0
Email: info.de@leviat.com

India

Leviat
309, 3rd Floor, Orion Business Park
Ghodbunder Road, Kapurbawdi,
Thane West, Thane,
Maharashtra 400607
Tel: +91 - 22 2589 2032
Email: info.in@leviat.com

Italy

Leviat
Via F.lli Bronzetti 28
24124 Bergamo
Tel: +39 - 035 - 0760711
Email: info.it@leviat.com

Malaysia

Leviat
28 Jalan Anggerik Mokara 31/59
Kota Kemuning, 40460 Shah Alam
Selangor
Tel: +603 - 5122 4182
Email: info.my@leviat.com

Netherlands

Leviat
Oostermaat 3
7623 CS Borne
Tel: +31 - 74 - 267 14 49
Email: info.nl@leviat.com

New Zealand

Leviat
2/19 Nuttall Drive, Hillsborough,
Christchurch 8022
Tel: +64 - 3 376 5205
Email: info.nz@leviat.com

Norway

Leviat
Vestre Svanholmen 5
4313 Sandnes
Tel: +47 - 51 82 34 00
Email: info.no@leviat.com

Philippines

Leviat
2933 Regus, Joy Nostalg,
ADB Avenue
Ortigas Center
Pasig City
Tel: +63 - 2 7957 6381
Email: info.ph@leviat.com

Poland

Leviat
Ul. Obornicka 287
60-691 Poznań
Tel: +48 - 61 - 622 14 14
Email: info.pl@leviat.com

Singapore

Leviat
14 Benoi Crescent
Singapore 629977
Tel: +65 - 6266 6802
Email: info.sg@leviat.com

Spain

Leviat
Polígono Industrial Santa Ana
c/ Ignacio Zuloaga, 20
28522 Rivas-Vaciamadrid
Tel: +34 - 91 632 18 40
Email: info.es@leviat.com

Sweden

Leviat
Vädursgatan 5
412 50 Göteborg
Tel: +46 - 31 - 98 58 00
Email: info.se@leviat.com

Switzerland

Leviat
Hertistrasse 25
8304 Wallisellen
Tel: +41 - 44 - 849 78 78
Email: info.ch@leviat.com

United Kingdom

Leviat
A1/A2 Portland Close
Houghton Regis LU5 5AW
Tel: +44 - 1582 - 470 300
Email: info.uk@leviat.com

United States of America

Leviat
6467 S Falkenburg Rd.
Riverview, FL 33578
Tel: (800) 423-9140
Email: info.us@leviat.us

For countries not listed

Email: info@leviat.com

Leviat.com

For information on certified management systems and standards see www.ancon.co.uk | www.aschwanden.com | www.halfen.com

Notes regarding this catalogue

© Protected by copyright. The construction applications and details provided in this publication are indicative only. In every case, project working details should be entrusted to appropriately qualified and experienced persons. Whilst every care has been exercised in the preparation of this publication to ensure that any advice, recommendations or information is accurate, no liability or responsibility of any kind is accepted by Leviat for inaccuracies or printing errors. Technical and design changes are reserved. With a policy of continuous product development, Leviat reserves the right to modify product design and specification at any time.



Imagine. Model. Make.

Leviat.com